

मोशन है, तो भरसा है

MOTION
18 YEARS OF LEGACY



SAMPLE QUESTION PAPERS

CBSE CLASS 12th

Class XII Session 2024-25
Subject - Biology Sample
Question Paper - 2

Time Allowed: 3 hours

Maximum Marks: 70

General Instructions:

1. All questions are compulsory.
2. The question paper has five sections and 33 questions. All questions are compulsory.
3. Section–A has 16 questions of 1 mark each; Section–B has 5 questions of 2 marks each; Section– C has 7 questions of 3 marks each; Section– D has 2 case-based questions of 4 marks each; and Section–E has 3 questions of 5 marks each.
4. There is no overall choice. However, internal choices have been provided in some questions. A student has to attempt only one of the alternatives in such questions.
5. Wherever necessary, neat and properly labeled diagrams should be drawn.

Section A

1. The amount of usable energy which is available for doing work, when the temperature and pressure are uniform throughout the system, is called: [1]
a) Free energy
b) Spontaneous energy
c) Activation energy
d) Enthalphy
2. Induced abortion is also called: [1]
a) STD
b) MTP
c) IUD
d) PID
3. Dodo is [1]
a) extinct
b) critically endangered
c) endangered
d) rare
4. A vasectomy: [1]
a) Prevents the production of sperms in the testes.
b) Prevents the movement of sperms into the urethra.
c) Prevents the production of semen.
d) Prevents from having erection.
5. The extraction of DNA from the agarose gel is called as: [1]
a) Isolation
b) Elution
c) Transformation
d) Ligation
6. A prokaryotic autotrophic nitrogen-fixing symbiont is found in: [1]

- a) Cycas
- b) Pisum
- c) Alnus
- d) Cicer

7. Study the pedigree chart given below:

[1]

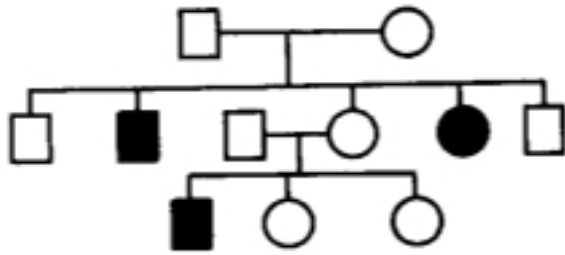

What does it show?

- a) The pedigree chart is wrong as this is not possible
- b) Inheritance of a recessive sex-linked disease like haemophilia
- c) Inheritance of a condition like phenylketonuria as an autosomal recessive trait
- d) Inheritance of a sex-linked inborn error of metabolism like phenylketonuria

8. The diagram represents miller's experiment. Choose the correct combination of labelling.

[1]

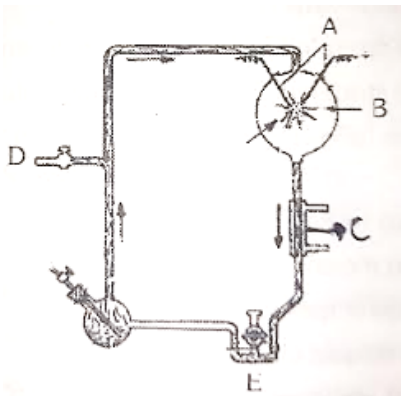

- a) A-electrodes, B-NH₃ + H₂O, C-hot water, D-tap, E-U trap
- b) A-electrodes, B-NH₄ + H₂ + CO₂ +CH₃, C-hot water, D-vacuum, E-U trap
- c) A-electrodes, B-NH₃ + H₂ + H₂O +CH₂, C-cold water, D-vacuum, E-U trap
- d) A-electrodes, B-NH₃ + H₂ + H₂O +CH₄, C-steam, D-vacuum, E-U trap

9. Biological equilibrium is an equilibrium among the:

[1]

- a) Producers and consumers
- b) Producers and decomposers
- c) Producers
- d) Producers, consumers and decomposers

10. Represented below is the inheritance pattern of a certain type of trait in humans. Which one of the following conditions could be an example of this pattern?

[1]

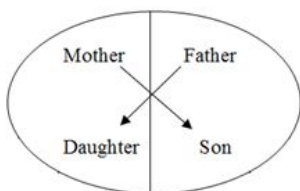

- a) Thalassemia
- b) Haemophilia
- c) Sickle Cell anemia
- d) Phenyl ketonuria

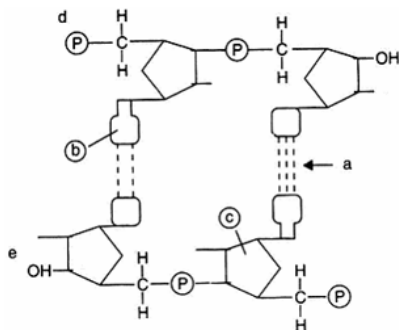

19. a. Draw an L.S. of pistil showing pollen tube entering into the embryo sac. Label the following: [2]
- Nucellus
 - Antipodals
 - Synergids
 - Micropyle
- b. Write the functions of the following:
- Synergids
 - Micropyle

20. Identify A, B, C and D with reference to gametogenesis in humans, in the flow chart given below. [2]

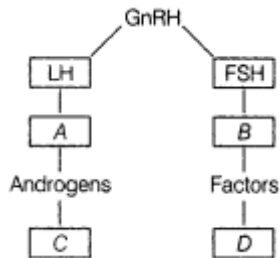

21. State the most important contribution of the following microbes for human welfare: [2]
- monascus purpureus
 - Trichoderma Polysporum

OR

Name the effective biocontrol agents of several plant pathogens belonging to group of viruses. Also write about the ways they support the environment.

Section C

22. i. Construct a complete transcription unit with promotor and terminator on the basis of the hypothetical template strand given below. [3]
- $\overleftarrow{\text{A T G C A T G C A T A C}}$
- ii. Write the RNA strand transcribed from the above transcription unit along with its polarity.
23. i. How does mutation occur? [3]
- ii. Differentiate between point mutation and frameshift mutation.
24. What is the association between the bumblebee and its favourite orchid Ophrys? How would extinction or change of one affect the other? [3]
25. The below image shows is the headquarter of Eli Lilly company. Eli lily is one of the first pharmaceutical companies to produce human insulin using RDT technology by cell-based fermentation method. [3]



- i. How did Eli Lilly synthesize human insulin?
 - ii. Mention one difference between this insulin and the one produced by the human pancreas.
26. Study the graphical representation of Species richness - Area relationship given below and answer the questions that follow: [3]

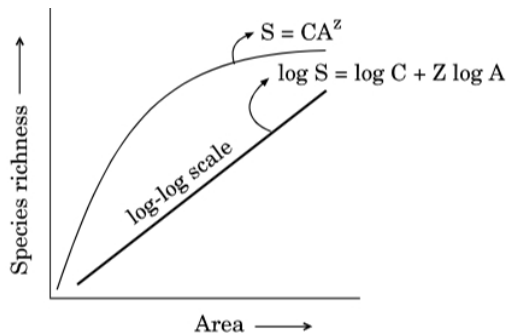

- a. What do S, C, Z and A represent in the given graph?
- b. What will be the range value of **Z** if we analyse the species-area relationship among very large areas like entire continent?

OR

Alien species are a threat to native species. Justify taking examples of an animal and a plant alien species.

27. Classify the following as examples of homology and analogy: [3]

(i)	Mouth parts of cockroach and butterfly
(ii)	Hearts of rabbits and human beings
(iii)	Eyes of octopus and mammals
(iv)	Sweet potato and potato
(v)	Stings of honey bee and scorpion
(vi)	Tendrils of Lathyrus and tendrils of Gloriosa

28. A patient complains of suffering from constipation, stomach ache, stool with blood clots and excess mucous. [3]
The physician diagnosed it as amoebiasis, after stool test.
- a. Write the scientific name of the microbe identified in the stool sample.
 - b. How do you think, the patient must have contracted it?
 - c. Write your suggestions to the patient to avoid infection in future.

Section D

29. Read the following text carefully and answer the questions that follow: [4]

The following is the illustration of the sequence of ovarian events (A-I) in a human female.

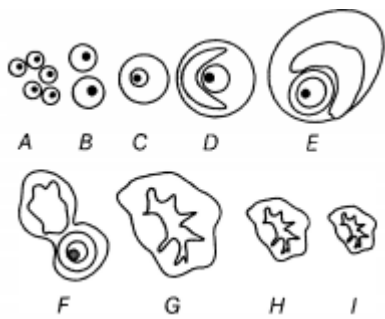

- Identify the figure that illustrates ovulation and mention the stage of oogenesis it represents. (1)
- Name the ovarian hormone and the pituitary hormone that have caused the above mentioned event. (1)
- Explain the changes that occur in the uterus simultaneously in anticipation. (2)

OR

Write the differences between C and H. (2)

30. **Read the following text carefully and answer the questions that follow:** [4]

The diagram shows the replication of the retrovirus in the host.

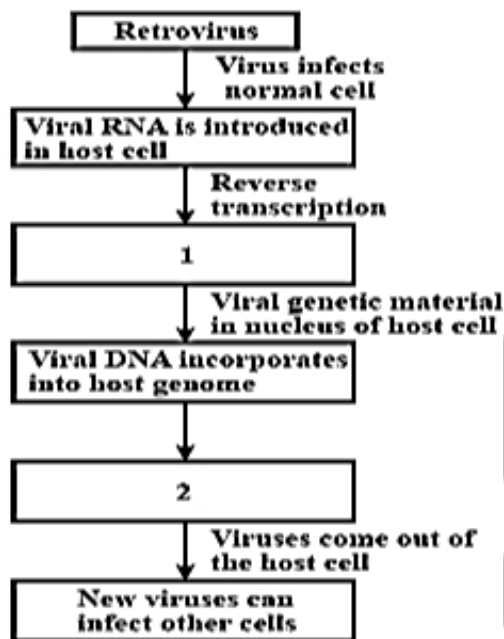

- Fill in the missing data in boxes labelled 1 & 2. (1)
- Why is it named as retrovirus? (1)
- While the virus is being replicated and released, does the infected cell survive and why the virus infected cells prevent spreading of virus to healthy cells? (2)

OR

What is the effect of HIV infection on immune system? (2)

Section E

31. a. Explain the process of syngamy and triple fusion in angiosperms. [5]
 b. Trace the development of the product of syngamy upto its mature stage in a dicot plant.
 c. Draw and label three important parts of a mature dicot embryo.

OR

- Draw a diagram of a fully developed embryo sac of an angiosperm. Label its chalazal end and any other five parts within the embryo sac.
- Why does the development of an endosperm precede that of the embryo in angiosperm?

c. Number of chromosomes in an onion plant cell is 16. Name the cells of the embryo sac having 16 and 24 chromosomes formed after fertilisation.

32. i. Name the type of DNA that forms the basis of DNA fingerprinting and mention two features of this DNA. [5]
 ii. Write the steps carried out in the process of DNA fingerprinting technique, and mention its application.

OR

In 1952, Alfred Hershey and Martha Chase took an effort to find the genetic material in organisms. Their experiments led to an unequivocal proof to DNA as genetic material.

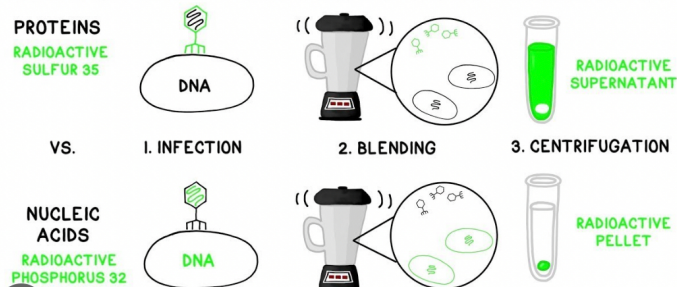

Answer the following questions based on Hershey and Chases’s experiments:

- i. Name the kind of virus they worked with and why?
 ii. Why did they use two types of culture media to grow viruses in? Explain.
 iii. What was the need for using a blender and later a centrifuge during their experiments? **OR**
 iv. State the conclusion drawn by them after the experiments.
33. Polymerase chain reaction (PCR) is a laboratory technique used to amplify DNA sequences. The method involves using short DNA sequences called primers to select the portion of the genome to be amplified. The temperature of the sample is repeatedly raised and lowered to help a DNA replication enzyme copy the target DNA sequence. The technique can produce a billion copies of the target sequence in just a few hours. [5]

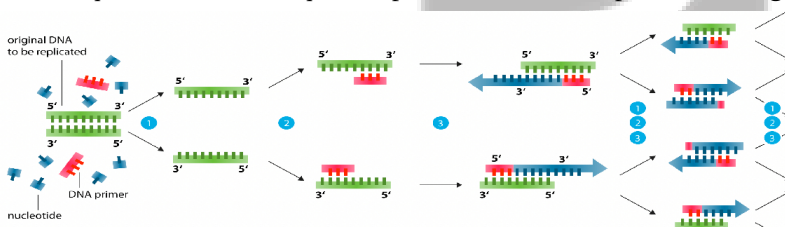

- i. List the three steps involved in Polymerase Chain Reaction (PCR).
 ii. Name the source organism of Taq polymerase.
 iii. Explain the specific role of this enzyme in PCR.

OR

How and why is the bacterium *Thermus aquaticus* employed in recombinant DNA technology? Explain.

Solution

Section A

1. (a) Free energy

Explanation: Free energy

2.

- (b) MTP

Explanation: MTP

3. (a) extinct

Explanation: The dodo is an extinct flightless bird that was endemic to the island of Mauritius, east of Madagascar in the Indian Ocean. The last confirmed sighting of a dodo was in 1681 and by the end of the 17th century, there were no dodos left.



4.

- (b) Prevents the movement of sperms into the urethra.

Explanation: Prevents the movement of sperms into the urethra.

5.

- (b) Elution

Explanation: The extraction of specific bands of DNA from agarose gels in which they are separated through electrophoresis is known as elution. There are many methods for eluting DNA from a piece of agarose.

6. (a) Cycas

Explanation: Cycas

7.

- (c) Inheritance of a condition like phenylketonuria as an autosomal recessive trait

Explanation: Inheritance of a condition like phenylketonuria as an autosomal recessive trait

8.

- (c) A-electrodes, B- $\text{NH}_3 + \text{H}_2 + \text{H}_2\text{O} + \text{CH}_2$, C-cold water, D-vacuum, E-U trap

Explanation: A-electrodes, B- $\text{NH}_3 + \text{H}_2 + \text{H}_2\text{O} + \text{CH}_2$, C-cold water, D-vacuum, E-U trap

9.

- (d) Producers, consumers and decomposers

Explanation: Producers, consumers and decomposers

10.

- (b) Haemophilia

Explanation: The inheritance pattern of a certain type of trait in humans shown above is haemophilia.

A son cannot inherit the defective gene from his father. This is a recessive trait and can be passed on if cases are more severe with the carrier. Genetic testing and genetic counselling are recommended for families with haemophilia. The disease is X-linked and the father cannot pass haemophilia through the Y-chromosome.

11.

- (d) Methanobacterium

Explanation: Excretory wastes of animals (gobar) is used to get manure and gobar gas. Gobar gas is a methane rich fuel gas

produced by the anaerobic breakdown of gober with the help of methanogenic bacteria present in the gober in very large numbers.

12. **(b)** Molecular weights of the fragments are different.
Explanation: Gel electrophoresis is a technique used to separate DNA fragments (or other macromolecules, such as RNA and proteins) based on their size and charge. Electrophoresis involves running a current through a gel containing the molecules of interest. Based on their size and charge, the molecules will travel through the gel in different directions or at different speeds, allowing them to be separated from one another.
During gel electrophoresis, different fragments move at different distances due to differences in their molecular weight of the fragments. Smaller fragments move more towards the anode.
13. **(b)** Both (A) and (R) are true, but (R) is not the correct explanation of (A).
Explanation: Both (A) and (R) are true, but (R) is not the correct explanation of (A).
Determining the sex of an unborn child followed by MTP (medical termination of pregnancy) is an illegal practice in many countries, including India. The government has banned the use of prenatal diagnostic techniques to determine the sex of the unborn child to prevent female feticide.
14. **(a)** Both A and R are true and R is the correct explanation of A.
Explanation: Azolla can co-exist with rice plants because it does not interfere with their growth. In some southeast Asian countries, especially China, the rice fields are regularly provided with Azolla. The fern is stocked in a corner of rice field and provided with manure, ash, and straw before transplantation. When the field is flooded at the time of transplantation, the fern spreads rapidly and covers the space in between the rice plants. Anabaena, a blue-green algae resides in the leaf cavities of the fern. It fixes nitrogen. A part of the fixed nitrogen is excreted in the cavities and becomes available to the fern. The decaying fern plants release the same for utilisation by the rice plants.
15. **(a)** Both A and R are true and R is the correct explanation of A.
Explanation: No energy that is trapped in an organism remains in it forever because the energy trapped by a producer/consumer is either passed to a consumer/secondary consumer or the organism dies.
16. **(a)** If both Assertion & Reason are true but the reason is not the correct explanation of the assertion
Explanation: The earliest organisms that appeared on the earth were non-green and presumably anaerobes as the primordial atmosphere was virtually oxygen-free.

Section B

17. Microorganisms such as Lactobacillus and others commonly called lactic acid bacteria (LAB) grow in milk and convert into curd. LAB produce acid that coagulate and partially digest the milk proteins.
Beneficial role - Increases Vitamin B₁₂ / Checks disease causing microbes in the stomach.
18. a. Hydrogen bonds
b. Purine base
c. Pentose sugar (Deoxyribose)
d. 5' end of the chain - d

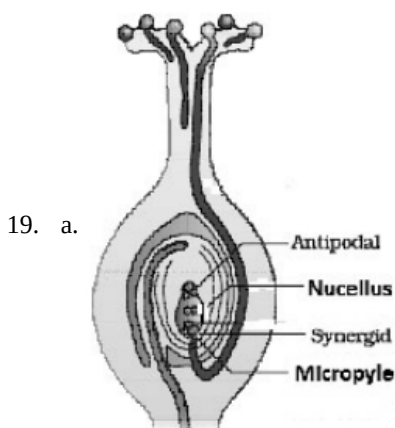

- b. i. Function - Synergids have Filiform apparatus which guides the entry of pollen tube to the embryo sac.
ii. Function - Micropyle allows the entry of pollen tube to embryo sacs.
20. A- Leydig's cell

- B- Sertoli cell
- C- Spermatogenesis (Formation of sperms)
- D- Spermiogenesis (Transformation of spermatid into sperm)

21. a. **Monascus Purpureus:** Statins produced by the yeast *Monascus purpureus* have been commercialised as blood-cholesterol-lowering agents. It acts by competitively inhibiting the enzyme responsible for synthesis of cholesterol.
- b. **Trichoderma Polysporum:** Cyclosporin A, that is used as an immunosuppressive agent in organ-transplant patients, is produced by the fungus *Trichoderma polysporum*.

OR

- i. Baculoviruses / Nucleopolyhedrovirus
- ii. Species specific, narrow spectrum insecticidal application, no negative impact on plants/ vertebrates / non-target insects, help to conserve beneficial insects, useful in IPM, useful in ecologically sensitive area

Section C

22. i. Transcription unit

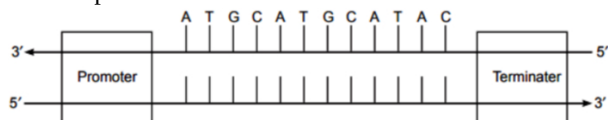

- ii. RNA strand transcribed from the above transcriptional unit

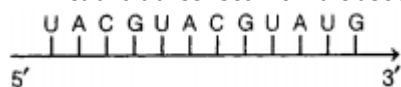

23. a. Loss(deletion) or gain (insertion / duplication /addition) or change in position of DNA segments / chromosome cause the mutation.
- b. Mutation due to change in a single base pair of DNA is point mutation, while insertion or deletion of one or two bases changes the reading frame from the point of insertion or deletion is frameshift mutation.
24. The association between the bumblebee and its favourite orchid *Ophrys* is of Commensalism. The extinction or change of one would certainly affect the other as if there are lesser bees, pollination may suffer and the orchid population may get decreased. On the other hand, if there are fewer orchids then bees may not be able to transfer the pollen.
25. Eli Lilly company prepares proinsulin chain A and B using separate DNA sequences corresponding to A and B, chains of human insulin and introduced them in the plasmid of *E. coli* to prepare insulin chains, chains A and B produced separately, extracted and combined by disulphide bond produces mature insulin.
- The one important difference between the insulin produced by human pancreas and the one produced by Eli Lilly is that human insulin has an additional C peptide.
26. a. S is the species richness
A is the area
C is a constant
Z is the regression constant.
- b. If the species-area relationships are analysed among very large areas like the entire continents, the value of Z, i.e., slope of line lies in the range of 0.1 to 0.2.

OR

When alien species are introduced in a particular ecosystem, they become invasive. Alien species compete for food and other resources which threatens survival of native species. For example:

- o The Nile Perch introduced in lake Victoria in East Africa led to the gradual extinction of more than 200 species of Cichlid fish in the lake. Introduction of African cat fish (*Clarias gariepinus*) for aquaculture purpose is posing threat to the indigenous catfish in our rivers.
- o Invasive weed species like water hyacinth (*Eichornia*), carrot grass (*Parthenium*) have posed a threat to our native species.

27. (i)	Mouth parts of cockroach and butterfly	homology
(ii)	Hearts of rabbits and human beings	analogy
(iii)	Eyes of octopus and mammals	analogy
(iv)	Sweet potato and potato	analogy
(v)	Stings of honey bee and scorpion	analogy

28. a. Amoebiasis; an infection of the large intestine caused by a protozoan, *Entamoeba histolytica*
 b. Source of infection:
 i. Cysts from the faeces of infected person
 ii. Contaminated raw vegetables, fruits and other food stuffs.
 iii. Through contaminated water.
 c. The infection can be avoided by
 i. Proper sanitary disposal of faecal matter.
 ii. Perfect sanitation and protection of water and vegetables from pollution.
 iii. Washing hands regularly.

Section D

29. i. Figure F illustrates ovulation. It represents the ovulatory stage of oogenesis.
 ii. Ovarian and pituitary hormones involved in causing ovulation are
Ovarian hormone Estrogen.
Pituitary hormone LH and FSH.
 iii. In anticipation of receiving the fertilised egg, the endometrium of the uterus gets thickened and also the blood supply to the endometrium increases.

OR

The figure C stage represents the secondary follicle and the H stage represents the degenerating corpus luteum.

Secondary follicle	Corpus luteum
It is surrounded by layers of granulosa cells and theca layer.	Layers of granulosa cells and theca cells are absent.
It contains an oocyte in the developing stage.	It does not contain oocyte as it is formed after the release of secondary oocyte.

30. i. 1. Viral DNA is produced by reverse transcription.
 2. New viral RNA is produced by the infected cell.
 ii. HIV has RNA genome; it produces DNA by reverse transcription.
 iii. Infected cell can survive and by releasing alpha-interferon.

OR

Due to HIV infection immune system gets suppressed as decrease in T-lymphocytes occurs.

Section E

31. a. Fusion of the male gamete with the nucleus of the egg cell is called syngamy, this results in the formation of the diploid zygote. Fusion of a male gamete with two polar nuclei, to produce triploid primary endosperm nucleus is called triple fusion. **or** One sperm cell fuses with the two polar nuclei, resulting in the formation of a triploid (3n) nucleus. This fusion event is known as triple fusion.
 b. The zygote divides mitotically at the micropylar end, (only after certain endosperm is formed) to give rise to proembryo, subsequently to mature embryo (globular and heart shaped)

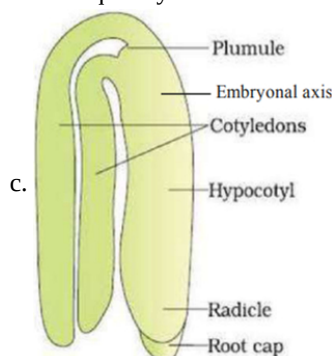

OR

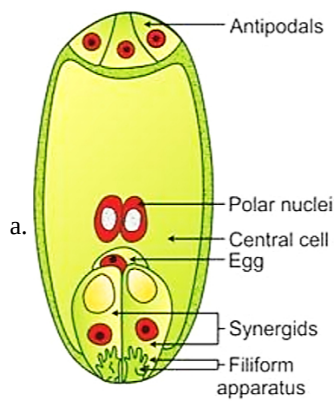

Mature Embryo Sac

- b. The development of an endosperm precede that of the embryo in angiosperm because the cells get packed with reserve food supplies, used for providing the nutrition to the developing embryo.
- c. Cells with 16 chromosomes is called zygote and cells with 24 chromosome is called endosperm.
32. i. Satellite DNA or repetitive DNA These sequences normally do not code for any proteins. These sequence show high degree of polymorphism.
- ii. Steps carried out in the process of DNA fingerprinting technique are:
- isolation of DNA.
 - digestion of DNA by restriction endonucleases
 - separation of DNA fragments by electrophoresis
 - transferring (blotting) of separated DNA fragments to synthetic membranes such as nitrocellulose or nylon.
 - hybridization on using labelled VNTR probe.
 - detection of hybridized DNA fragments by autoradiography
- The applications of DNA fingerprinting technique are in Forensic science / determining population and genetic diversities / paternity test.

OR

- They worked with bacteriophage, i.e. viruses that infect bacteria. These viruses were used because during infection they transfer their genetic material into bacteria.
 - They used two types of culture media, containing ^{35}S and ^{32}P , so as to compare that which one out of DNA and proteins gets transferred from virus to bacteria and act as genetic material.
 - A blender and centrifuge were used to open up the bacterial cells and viral particles, so, that genetic material could be visualised.
 - They concluded that DNA is the genetic material that is passed from virus to bacteria.
33. i. Amplification of recombinant DNA gene is done using Polymerase Chain Reaction (PCR).
It is carried out in the following steps:
- Denaturation** -The double-stranded DNA is denatured by applying high temperature of 95°C for 15 seconds. Each separated strand acts as a template.
 - Annealing** -Two sets of primers are added, which anneal to the 3'end of each separated strand.
 - Extension**- DNA polymerase extends the primers by adding nucleotides complementary to the template provided in the reaction. Taq polymerase is used in the reaction, which can tolerate heat. All these steps are repeated many times to get several copies of the desired DNA.
- ii. The DNA polymerase used in PCR is Taq polymerase extracted from *Thermus aquaticus*. It is a thermostable enzyme that can withstand the high temperature used in the denaturation and separation of DNA strands. Hence, it can be used for a number of cycles of DNA amplification without being denatured.

OR

The bacterium *Thermus aquaticus* is employed and used for amplification of the gene of interest using PCR technique. Usually Taq (*Thermus aquaticus*) DNA polymerase, a thermostable enzyme is isolated from a thermophilic bacterium. The enzyme extends the two primers towards each other in order to copy the DNA segment (act as a template) lying between the two primers.

The step requires the presence of deoxynucleoside triphosphates and Mg^{2+} and occurs at 72°C .

If these cycles are repeated many times, the DNA segment can be amplified to approximately a billion times the DNA segment are made.

i. These are restriction endonucleases enzymes which cut the DNA molecule at the specific base sequences into fragments with sticky ends.

e.g., Eco RI, Hind II

ii. The enzyme restriction endonuclease cleaves DNA at a specific site resulting in the formation of fragments with single strand portions at the ends called sticky-ends. In practice, the digestion by the restriction enzyme keeping all other conditions at the optimum level and checked by using agarose gel electrophoresis technique.



YOUR SUCCESS STARTS HERE



ADMISSION OPEN (JEE/NEET)

DROPPER/ACHIEVER BATCH
26th March 2025

MOTION

PRE-ENGINEERING
JEE (Main+Advanced)

PRE-MEDICAL
NEET

Olympiads (Class 6th to 10th)
Boards

CORPORATE OFFICE

"Motion Education" 394, Rajeev Gandhi Nagar, Kota 324005 (Raj.)

Toll Free : 18002121799 | www.motion.ac.in | Mail : info@motion.ac.in

**MOTION
LEARNING APP**



Scan Code for Demo Class